

**B**

VS 10-75 CG OPTIMA  
VS 40-150 CG OPTIMA SUP  
VS 40-150 CG OPTIMA SUP-EXH

APPLICATION: AS72-S / AS72-R  
AS200-S / AS200-R

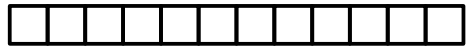

common ground terminal GND

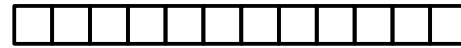

common terminal 24VAC

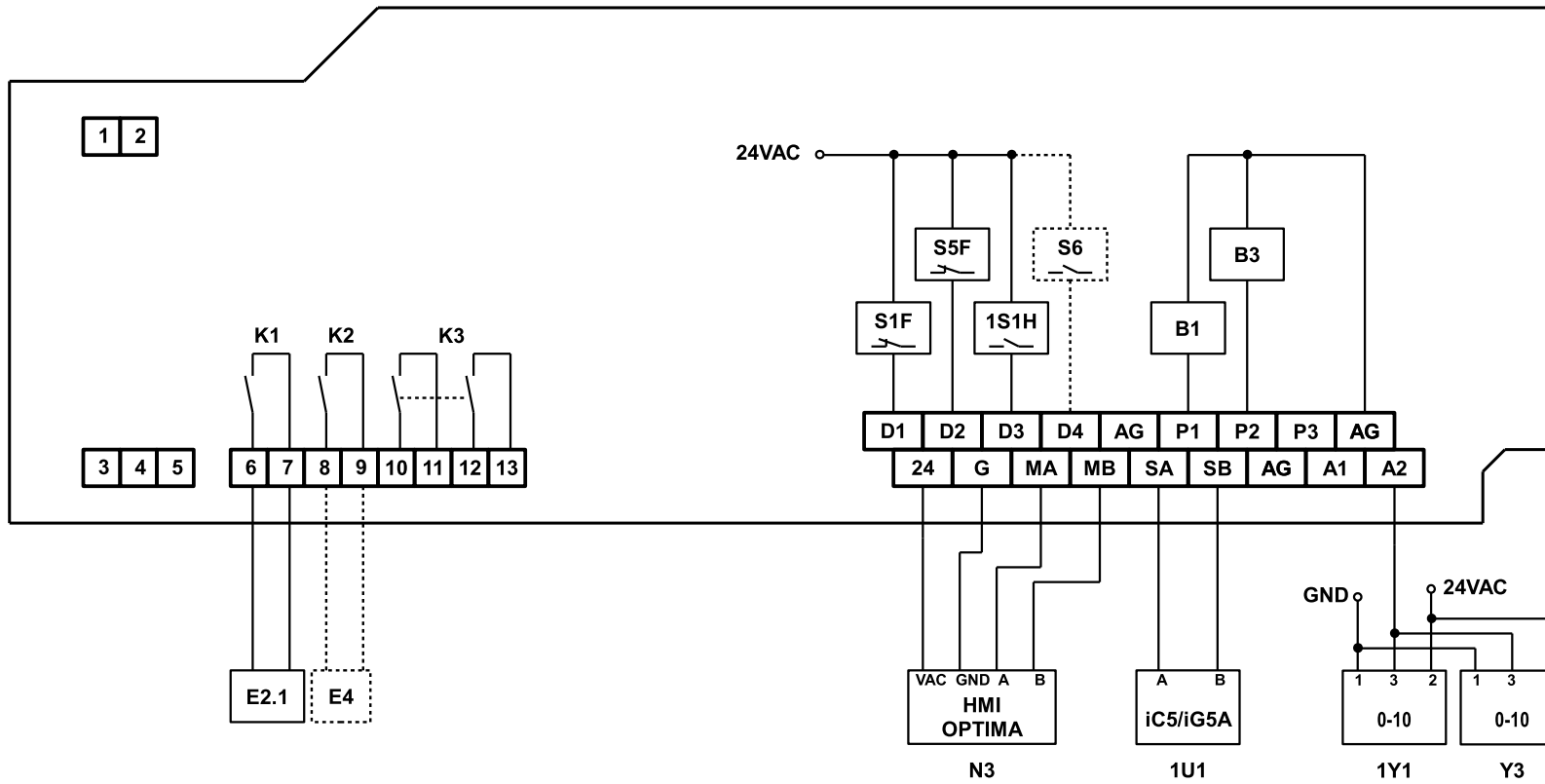

**B**

VS 10-75 CG OPTIMA  
VS 40-150 CG OPTIMA SUP  
VS 40-150 CG OPTIMA SUP-EXH

RS485 / Modbus connection details

